



water solutions

CIVIL/INDUSTRIAL



HIGH EFFICIENCY
SUBMERSIBLE
ELECTRIC PUMPS

 **UNIQA[®]**

zenit.com

EN



ZENIT

ZENIT

ZENIT

ZENIT



 **UNIQA**[®]

Innovation.

Reliability.

Efficiency.



water solutions

Why UNIQA?

The **UNIQA** range is designed to meet the real needs of civil and industrial wastewater pumping applications.

Its design centres on **3 key concepts**, which guided the Zenit engineers in the creation of a genuinely hi-tech product.



Innovation

Innovating means improving, starting with yourself.

We have responded with enthusiasm to a fast-changing market and worked passionately to deliver a high-quality product, the shining gem of today's Zenit range.

UNIQA is innovative in performance and technology.



Reliability

A product's quality lies first and foremost in its **reliability**, meaning trouble-free operation with low maintenance.

UNIQA is the outcome of painstaking design, machining on state-of-the-art machining centres, and meticulous assembly where the worker's experience plays a vital role.



Efficiency

Since operating costs usually account for a higher proportion of expenditure than other cost factors (purchase, installation and maintenance), design engineers aim to maximise efficiency to reduce running costs.

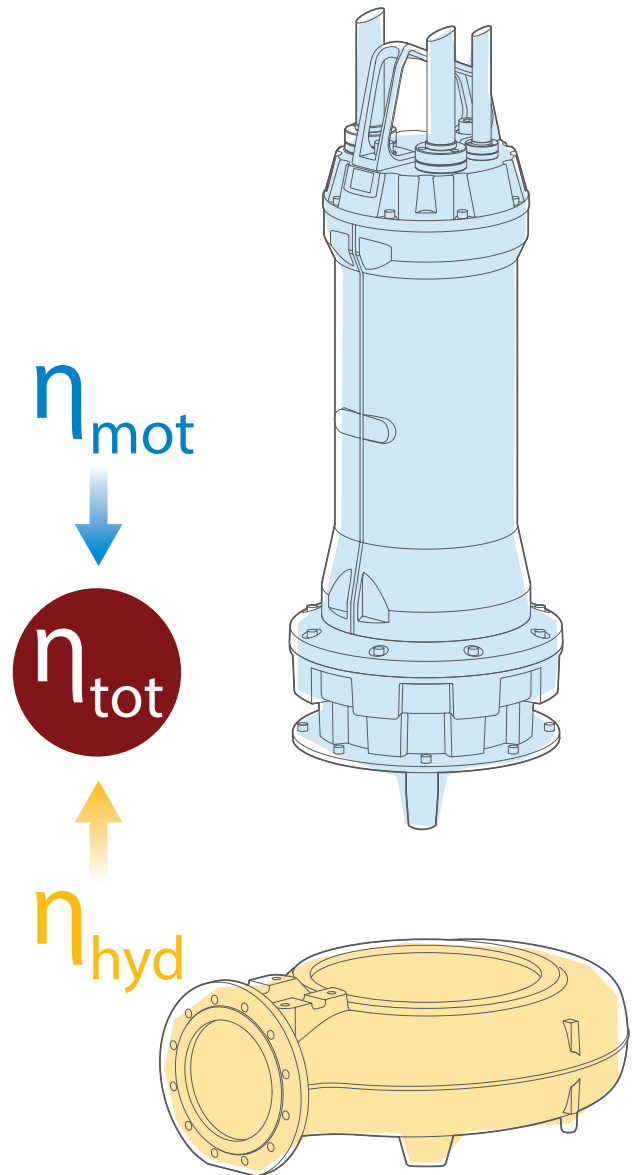

The **UNIQA** range is designed to be **modular**:

the breadth of range allows an energy-saving **motor** in Premium IE3 class to be combined with high-efficiency **hydraulics** optimised for the duty point.

The result? High total efficiency and sharply lower costs and environmental impact.

Tailor-made solutions

Every **UNIQA** model is developed to give the best performance for the duty point, with energy saving assured by efficiency class IE3 motors and high-performance hydraulics.

Combining a multinational mentality with flexibility, Zenit guarantees effective solutions and products and systems that are genuinely "made to measure".

A modular range

The **UNIQA** series is designed with **modularity** in mind. This approach gives the customer access to a large number of motor-hydraulics-material combinations, so every model is optimised for its intended use. In practice, hydraulics of a given diameter and material can

be fitted with motors with different powers and rpm for peak efficiency, and different types, dimensions and builds of impeller can be chosen depending on the specific criticalities of the application.

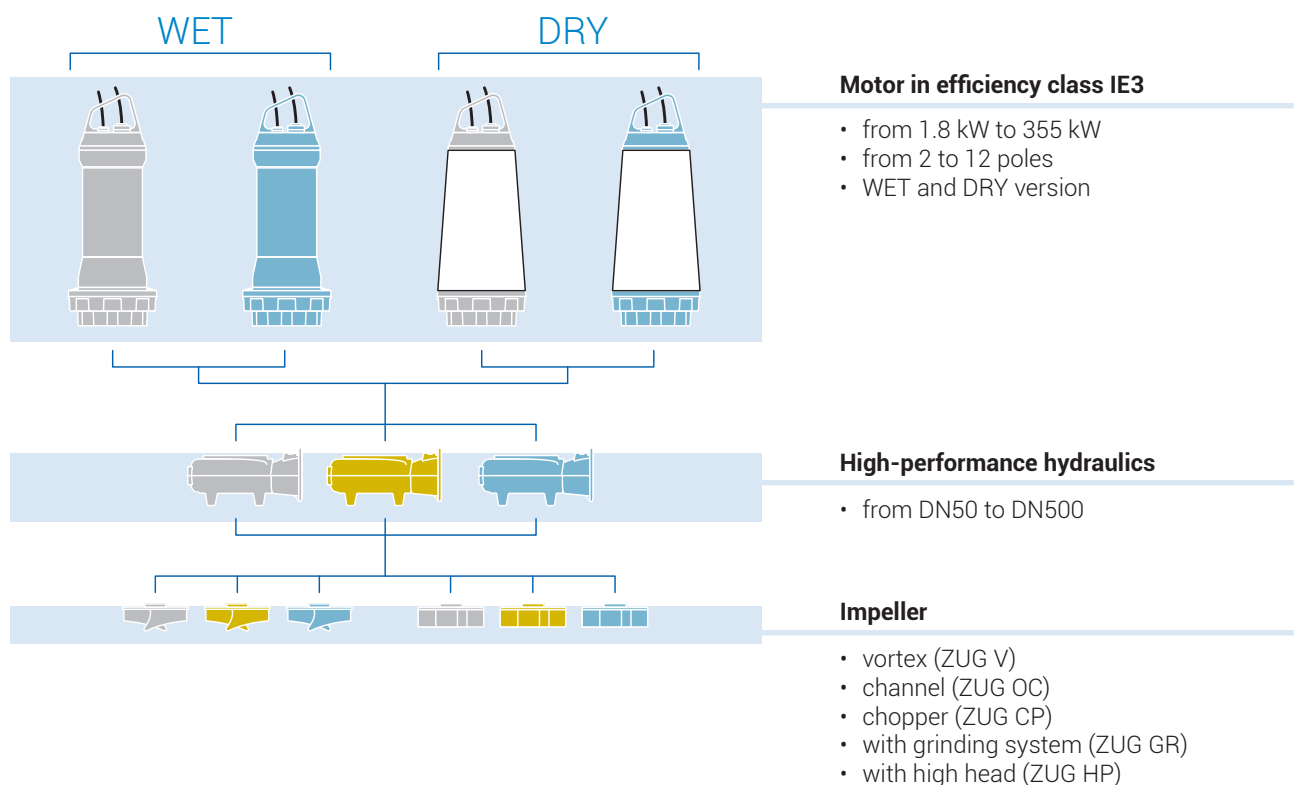

More materials, more reliability

To deal with special and specific applications, the standard iron hydraulics can be replaced with an alternative solution in bronze, stainless steel or *Molib-tech™*, an **innovative material** that guarantees constant performance even with very abrasive liquids, and significantly longer lifetime than conventional ceramic coating systems.

This means longer maintenance intervals, less inconvenience from system stoppages and lower incidence of running costs than with conventional pumping systems.

Characteristics

- Cast iron structure (stainless steel on request)
- Class H electric motor from 1.8 kW to 355 kW in efficiency class IE3
- 50 Hz and 60 Hz versions
- Thermal protection devices incorporated in stator
- Long life bearings (100,000 hours)
- AISI 431 drive shaft (AISI 329 on request)
- Leakage detection system in seal chamber (standard) and motor (on request)
- Two silicon carbide mechanical seals in large oil chamber and V-rings
- Discharge from DN50 to DN600
- Large free passage declared for every model
- PATENTED closed jacket cooling system with internal recirculation.
- Operating temperature up to 60°C (up to 80° on request)
- ATEX II 2G Ex db k IIB T4 / II 2D Ex tb IIIC T135°C certification



Overview of operating ranges

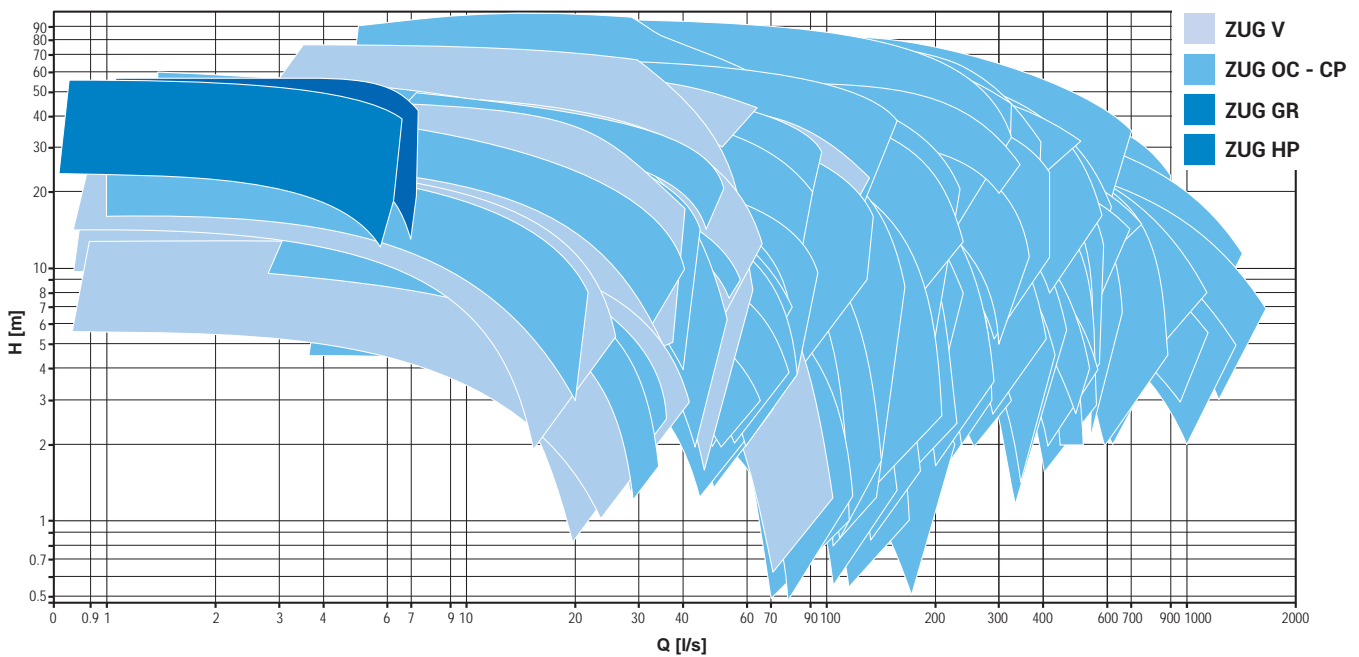

Construction materials

	Standard	Optional
Lifting handle	Stainless steel	-
Motor complex	EN-GJL 250	Stainless steel
Drive shaft	AISI 431	AISI 329
Cooling jacket	AISI 304	-
Gaskets	NBR	VITON
Nuts and bolts	A2-70 Stainless Steel	A4-80
Hydraulics	EN-GJL 250	AISI 316 / AISI 329 Duplex / Molib-tech™
Impeller	EN-GJL 250	AISI 316 / AISI 329 Duplex / Br-Al / Molib-tech™

Standard equipment and options

	Standard	Optional	
Power supply voltage	400 V	230, 500, 230/400, 440, 500/866 V	
Power voltage tolerance	max ± 10% (S3 duty)	-	
	max ± 5% (S1 duty)		
Efficiency class	IE3 - Premium Efficiency	IE2 - High Efficiency	
Power supply	3~ 50 Hz	VFD - 60Hz	
Motor insulation class	H	-	
Starting	Y Δ	Direct, Soft Start	
Maximum ambient temperature	40 °C	60 °C or above	
Type of cable	S1RN8-F or equivalent	EMC (VFD)	
Cable length	10 m	20 - 30 - 40 - 50 m	
Painting	Bicomponent epoxy - 200 μm	Bicomponent epoxy - 400 μm	
Mechanical seals	2 SiC/SiC mechanical seals in oil chamber	-	
Thermal sensors	Bimetal thermal sensors (150 °C)	PTC/PT100 thermistors	
Type of installation	Submersible	Dry	
Oil chamber/ motor	compartment water leakage sensor (single signal)	YES	-
	oil chamber	NO	YES
	motor compartment	NO	YES
	motor compartment cover	NO	YES
Sacrificial anodes	NO	YES	
Vibration sensors (bearings)	NO	YES	
Temperature sensors (bearings)	NO	PTC/PTC100	
ATEX certification	NO	YES (II 2G Ex db k IIB T4 / II 2D Ex tb IIIC T135°C)	

The data provided are not binding.
Zenit reserves the right to modify any product without notice.



Data Booklet

The technical data and hydraulic performances of the main **UNIQA** models are provided in the relative **Data Booklet** available for download from the website.

www.zenit.com



The **ZENO Pump Selector** application provides useful assistance during the electric pump selection and configuration process, and the product that meets the search parameters can be swiftly identified through selection by duty point or by choosing the type of hydraulics directly.

Your guide to UNIQA



-EX
 Range with certification
 ATEX II 2G Ex db k IIB T4 / II 2D Ex tb IIIC T135°C

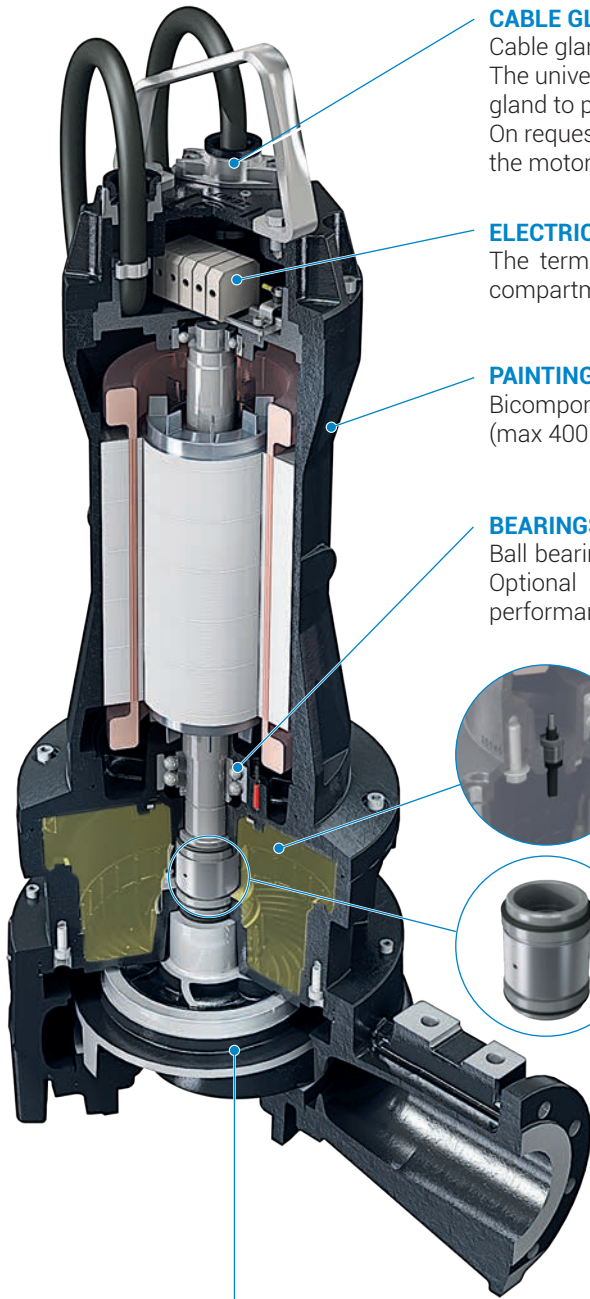

CABLE GLAND

Cable gland system with cable holder.
 The universal thread ring-nut can be removed to fix a rigid or flexible duct to the cable gland to protect the cable from physical and mechanical stresses.
 On request a special resin seal is applied to prevent all possibility of water leaking into the motor even if the outer sheath is torn.

ELECTRICAL CONNECTIONS

The terminal board, which simplifies electrical wiring procedures, is in an airtight compartment which can be fitted with a leakage detection sensor.

PAINTING

Bicomponent epoxy paint, standard thickness 200 µm
 (max 400 µm on request)

BEARINGS

Ball bearings with lifetime lubrication designed to guarantee 100,000 working hours.
 Optional sensors can monitor temperature and vibration to guarantee optimal performance.

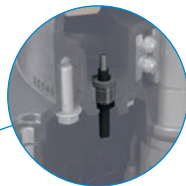

WATER SENSOR

Sensor fitted as standard to detect water or moisture in the mechanical seal oil chamber.
Also standard on ATEX version models.

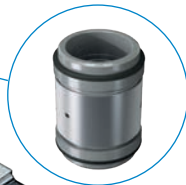

MECHANICAL SEALS

Two silicon carbide mechanical seals in oil sump and V-rings to ensure excellent reliability even in heavy-duty conditions.

SUCTION and DISCHARGE

The suction and discharge flanges can be ordered with holes of any standard type (UNI, ANSI, BS, etc.) to ensure perfect compatibility with the system and the accessories installed.



ZUG V
 Vortex
 hydraulics



ZUG OC
 Channel
 hydraulics



ZUG CP
 Chopper
 hydraulics



ZUG GR
 Grinder system
 hydraulics



ZUG HP
 High head
 hydraulics

Exclusive cooling system

In DRY version models, the motor is cooled by a water-glycol mix circulating in a special closed circuit.

The mix is recycled through the pump by an **axial impeller** rigidly mounted on the shaft and the specially designed steel **double jacket** which provides the necessary **heat exchange** between the motor and the external environment.

Thanks to this unique system:

- the cooling mix is **always separate from the wastewater** in which the pump is immersed and cannot be contaminated even if water leaks into the oil chamber due to wear of the first mechanical seal
- the mechanical seals are installed in an **oil chamber separated** from the cooling system and can be changed without draining the circuit

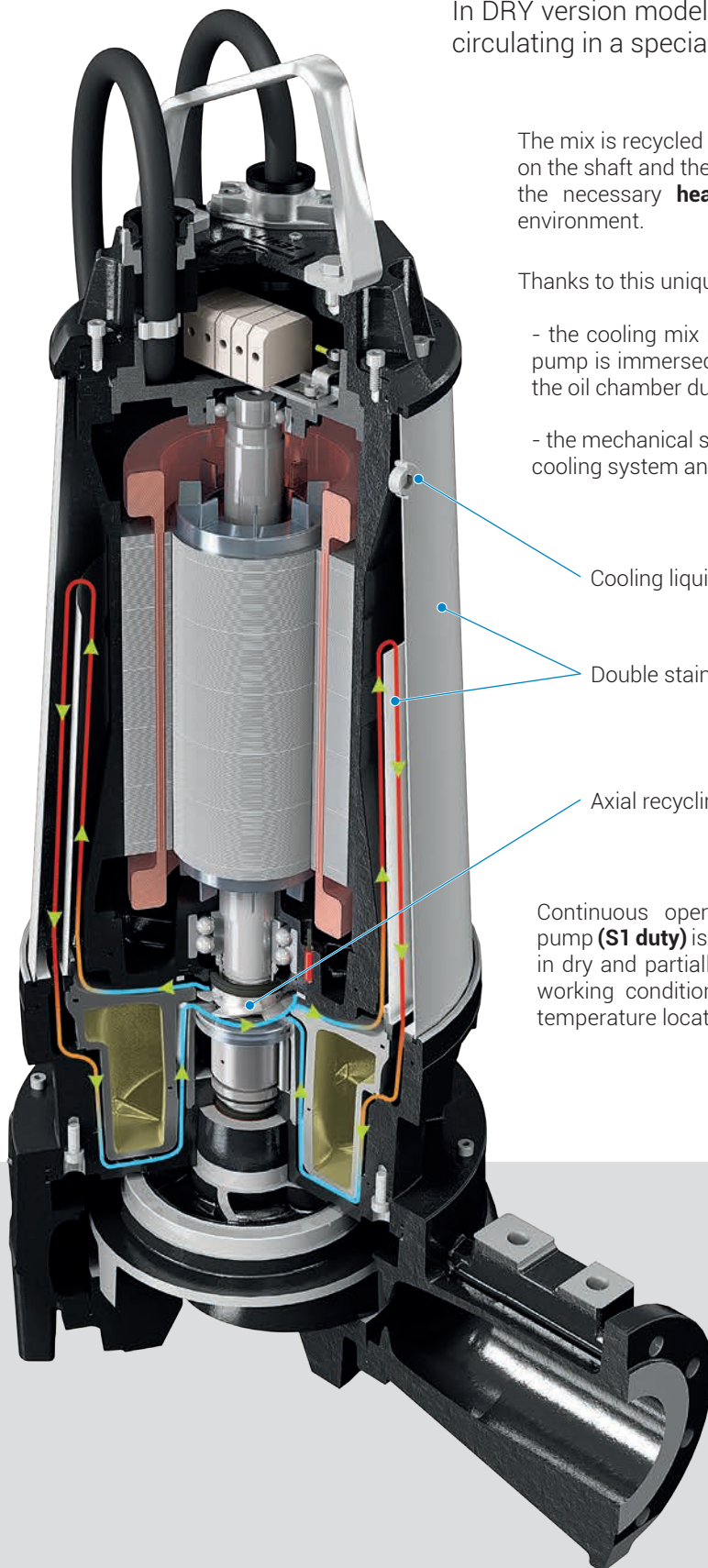

Cooling liquid inspection and filler cap

Double stainless steel jacket

Axial recycling impeller

Continuous operation of the pump (**S1 duty**) is ensured even in dry and partially submerged working conditions or in high temperature locations.

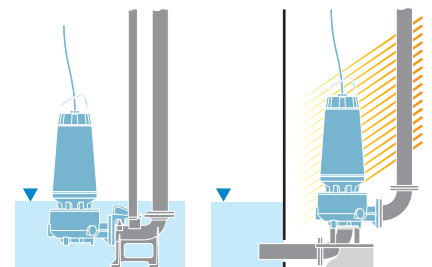
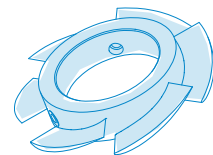

No unpleasant surprises

If the outer mechanical seal wears, the **sensor** warns that water is leaking into the oil chamber.

The second mechanical seal allows the pump to continue operating temporarily, allowing **scheduling of the maintenance job** with no need for unplanned system stoppages.

High efficiency motor

The heart of the **UNIQA** range lies in its high-efficiency electric motors, designed to deliver high performances and withstand continuous duty cycles.



- **PREMIUM IE3** efficiency
- **NEMA Class A**
- **Class H** insulation for all models in the range.

S1 duty mode operation even in water at a temperature of 60°C or above.

Clogging-proof hydraulics

All hydraulic components are designed using latest-generation software for the highest efficiency and the **best performance** while still ensuring ample free passages.

All models with channel hydraulics feature an **axial adjustment system** allowing the impeller clearance to be restored, to maintain performance even further to normal wear and tear.

The **ACS (Anti-Clogging System)** consists of a spiral groove of suitable depth cut into the diffuser plate. This prevents clogging of the impeller even with heavily soiled liquids, allows stringy items to be pulled out or unwound and renders the hydraulics clogging-proof.



More reliability with Molib-tech™

This **new material**, adopted by Zenit, is particularly suitable for preventing serious wear due to erosion or cavitation on pump impellers, suction flanges and bodies.



Through a complex research project, Zenit has developed a **new material** to:

- increase components' strength
- improve reliability
- keep performance constant over time even in extreme duty conditions.

This material, called *Molib-tech™*, is an alternative to the conventional ceramic coating process and **applies a layer of high-strength material to the iron**, to improve the product's **mechanical and performance characteristics**.

Unlike a conventional ceramic coating, the **uniform layer** of material does not cause any change in clearance or loss of performance.



ZENIT
water solutions

ARMATA
5,0 t
FEM
2.0

Monitoring

Every **UNIQA** model can be fitted with sensors for swift signalling of any anomaly, allowing quick action to protect the pump from potential damage.

The monitoring system also acquires data on the operation of the machines installed and helps in the targeted **planning of maintenance** to avoid sudden system shutdowns.

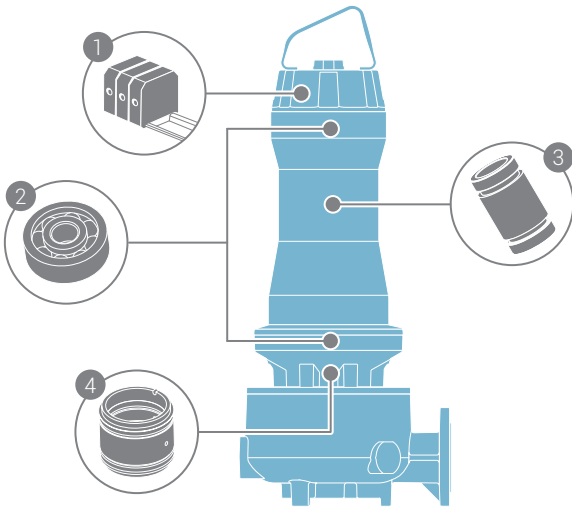

① **Terminal board:** water sensor that detects any leakage of water through the top cover to protect the motor (on request).

② **Bearings:** sensor (PT100) that signals overheating (on request) and vibration sensor warning of any impeller imbalance due to damage or cavitation (on request).

③ **Motor:** overheating bi-metal sensor (standard). PTC - PT100 on request. Independent sensors on each winding. Leakage detection sensor (on request).

④ **Oil chamber:** Water sensor (on request)

Maintenance

The **UNIQA** range has been carefully, rationally designed to ensure **easy maintenance** and **quick replacement** of parts subject to wear and tear.

- **CABLE**
All electrical connections are easily acceptable inside the top cover. A terminal board simplifies disconnection of the cable in the event of replacement.
- **MECHANICAL SEALS**
Once the impeller has been removed, the oil chamber containing the mechanical seals is accessed by just removing the ring-nut that holds them in place.
- **OIL**
The oil in the mechanical seal chamber can easily be replaced thanks to caps accessible from the outside regardless of whether the pump is installed horizontal or vertical.
- **BEARINGS**
They have standard characteristics, for low-cost maintenance and trouble-free sourcing of replacement parts.
- **Cooling liquid**
The water-glycol mix that cools the motor is in a closed circuit and does not need changing even in case of prolonged use.





water solutions

Research and development

Zenit has a department where **innovative solutions** are developed by specialist engineers using CAD programs and three-dimensional fluid-dynamic simulation systems.

Devices' hydraulic behaviour can be predicted and their criticalities analysed in the design phase, even before construction of the prototype, cutting costs and shortening times to market.

The **R&D department** also has access to a new testing laboratory, featuring a 9 metre square tank 10 metres deep able to contain 750 m³ of water, enabling technical trials on any product.

EVERY ZENIT PRODUCT IS THE OUTCOME OF A MODERN, FLEXIBLE ORGANISATION, PAINSTAKING DESIGN AND METICULOUS ASSEMBLY.



After-Sales Service

Customer orientation means not just quality but also continual assistance to our customers throughout all phases of the sales process, to guarantee total satisfaction and build a solid partnership far stronger than the usual business relationship.

Zenit is organised to deliver:



PRE-SALES SERVICE

To guide engineers and designers in the choice of the best solutions for their systems, in terms of efficiency as well as cost;



CONSULTING

To provide technical staff and construction site managers with the right support during installation of machines, through detailed documentation and site visits;



AFTER-SALES SERVICE

To support maintenance and repair engineers with an efficient parts distribution service and a full network of Authorised Service Centres.

There's a solution



WE DELIVER
WASTEWATER
TREATMENT
SOLUTIONS
WORLDWIDE



for every application **UNIQA**[®]



EVERY UNIQA MODEL
IS OPTIMISED
FOR ITS
INTENDED USE



Applications

Civil lifting



Application

The collection and disposal of **urban wastewater** are of primary importance to safeguard health requirements. These applications require plants designed to serve a large number of users, often in complex, heavy-duty situations.

Characteristics

Soiled wastewaters with solids

Solution

ZUG V, ZUG OC



Lifting sewage



Application

Lifting sewage is a complex problem that demands reliable products, due to the solids present and the high number of starts per hour generally required.

Characteristics

Unstrained wastewater with large solids

Solution

ZUG CP, ZUG GR



Draining



Application

Rainwater and **groundwater** needs to be removed quickly to prevent damage to the community and public and private property.

This has increased the demand for efficient solutions capable of transferring wastewater and rainwater containing not only solids but also pollutants and abrasive substances.

Characteristics

Wastewater with solids and dirt from first rainfall and yard sluicing tanks.

Solution

ZUG V, ZUG OC with large free passage



Industry



Application

Industrial processes require reliable, efficient pumping systems and equipment to guarantee high performance and prevent unplanned stoppages.

Systems of this kind may involve high heads, explosive liquids or environments contaminated with chemicals and corrosive substances, brine or process waters and high temperatures.

Characteristics

Sewage and process water

Solution

ZUG OC with Molib-tech™, stainless steel or bronze impeller with ATEX certification if required



Agriculture



Application

Agricultural wastewater lifting is one of the toughest challenges, due to the complexity of the operating contexts. The liquids for transfer are often heavily soiled and dense, containing filaments which require chopping before discharge into the main drain leading to the sewer.

Characteristics

Soiled wastewater with solids and fibres

Solution

ZUG CP, ZUG V



Water features and irrigation



Application

Irrigation and **theme park water pumping** can also pose serious difficulties, due to the high pressure required and the potential presence of sand and suspended particles.

Motors operating at high rpm with long duty cycles and particularly hard-wearing materials are needed.

Characteristics

Clear or slightly soiled wastewaters

Solution

ZUG HP



ZUG V

Operating ranges

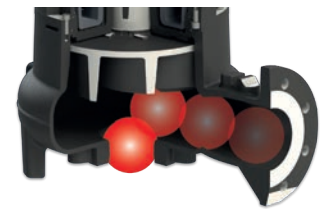
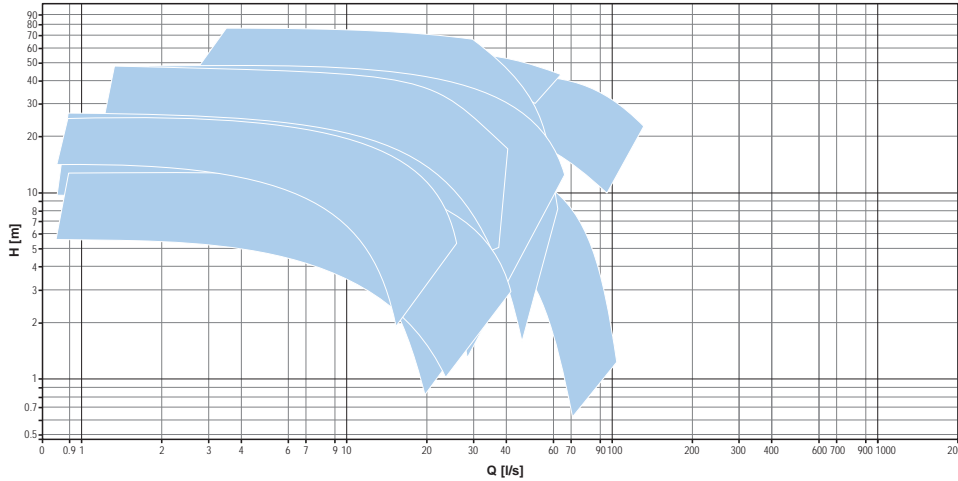

Range characteristics

Power	3 ÷ 45 kW
Poles	2 / 4
Discharge	DN65 ÷ 150
Free passage	max 125
Max flow rate	110 l/s
Max head	75 m

Hydraulics

- Vortex impeller
- Full free passage

Suitable for

- Liquids containing suspended solids
- Sewage and drainage systems and first rainfall tanks

Need

- Lifting of water from first rainfall tanks

Criticalities

- Wastewater containing dirt, solids and pollutants.
- Long periods out of use alternating with frequent work cycles

Zenit solution

UNIQA with vortex impeller (**ZUG V**):

- full free passage preventing fouling of the impeller, ensuring trouble-free operation
- high-efficiency class IE3 motors ensuring low power drawdown to keep operating costs down even with prolonged operations.

Lifting station pumping rainwater from collection tanks (Italy)
Four ZUG V 100B 5.5/4 AW pumps

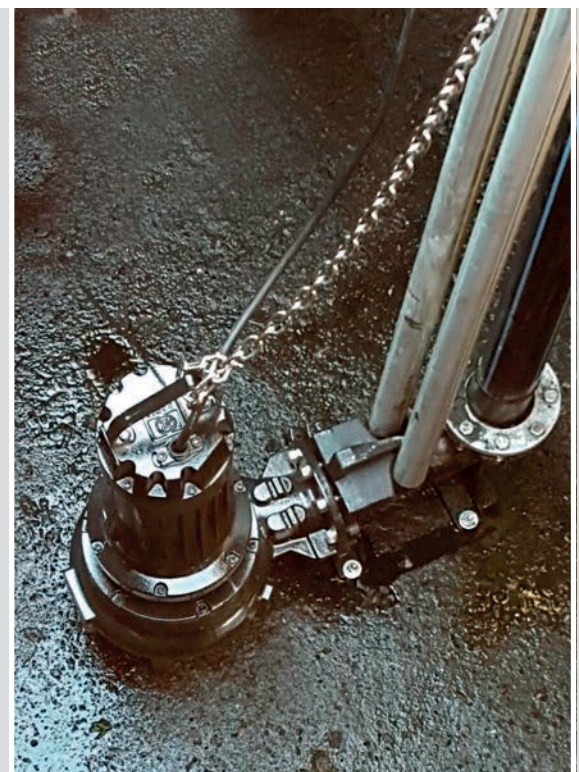

ZUG OC

Operating ranges

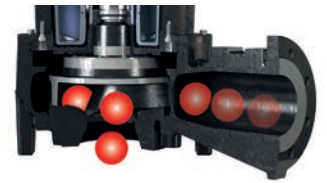
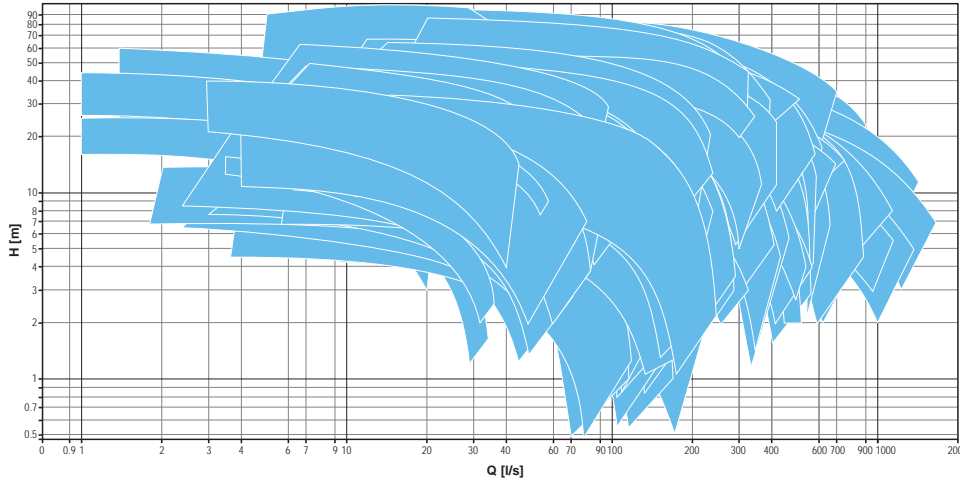

Range characteristics

Power	1.8 ÷ 355 kW
Poles	2 / 4 / 6 / 8 / 10 / 12
Discharge	DN80 ÷ 600
Free passage	max 220 x 110 mm
Max flow rate	1600 l/s
Max head	100 m

Hydraulics

- Channel impeller
- High hydraulic performances

Suitable for

- Dense, heavily soiled wastewater
- Sewage treatment systems, civil and industrial lifting



Need

- Lifting of soiled wastewater with high flows

Criticalities

- Soiled, dense liquids with traces of potentially explosive substances

Zenit solution

UNIQA with channel impeller (ZUG OC)

- high hydraulic efficiency
- version with cooling jacket to use with S1 duty mode in dry chamber
- use with flushing valve to keep the wastewater in motion and reduce collection tank cleaning requirements

Sewage pumping system (Thailand)
Twelve ZUG OC 300G 315/4 AD pumps

ZUG CP

Operating ranges

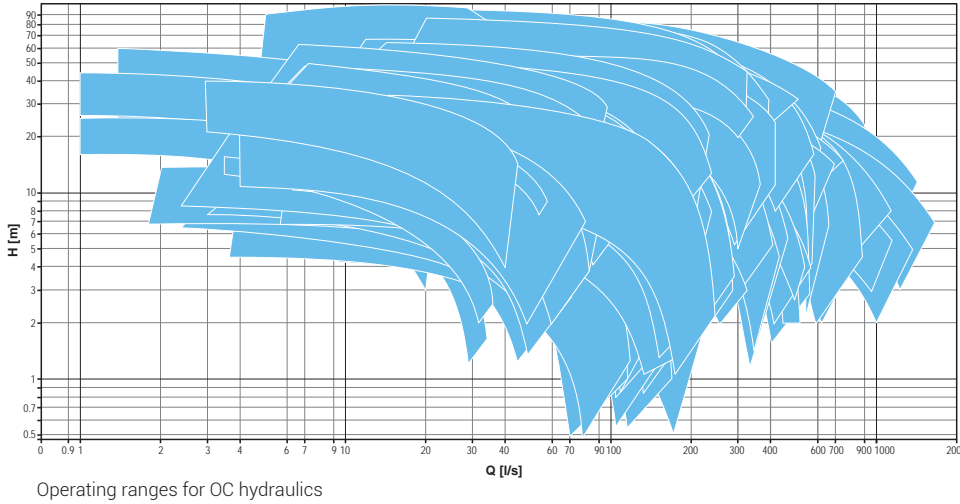

Range characteristics

Power	3 ÷ 355 kW
Poles	2 / 4 / 6 / 8 / 10 / 12
Discharge	DN80 ÷ 600
Free passage	max 220 x 110 mm
Max flow rate	1600 l/s
Max head	100 m

Hydraulics

- Chopper impeller with Molib-tech™ treatment as standard
- Solids grinding system and anti-fouling hydraulics for virtually unlimited free passage

Efficiency of hydraulics only 2/3% less than that of a normal channel impeller

Suitable for

- Liquids containing large-sized solids which can be broken down
- Sewage systems

Need

- Lifting of unstrained sewage sludge

Criticalities

- Presence of solids of various types and sizes

Zenit solution

UNIQA with chopper impeller (**ZUG CP**):

- impeller with chopper system
- high flow to ensure rapid emptying and prevent sedimentation

Pumping station for heavily soiled sewage (Italy)
Four ZUG CP 250B 45/6 AW pumps



ZUG GR

Operating ranges

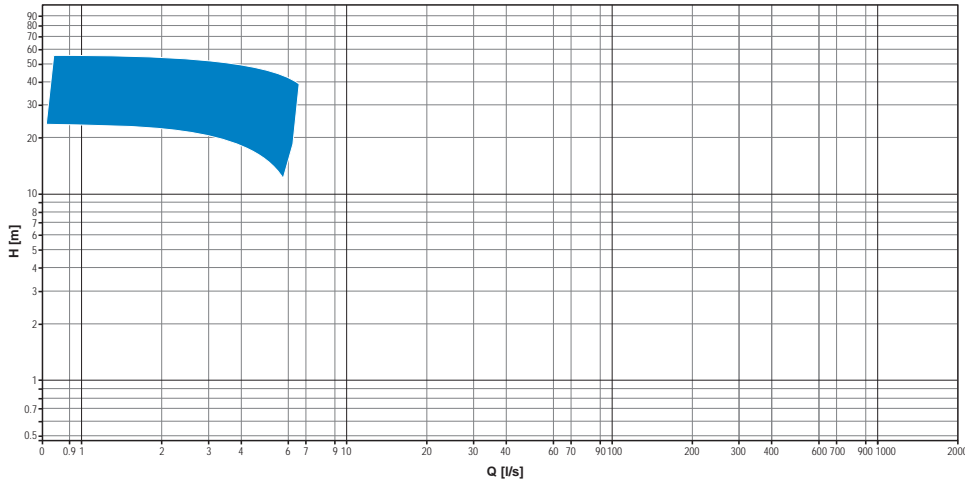

Range characteristics

Power	4 ÷ 11 kW
Poles	2
Discharge	DN50 ÷ G2"
Free passage	-
Max flow rate	8.0 l/s
Max head	57 m

Hydraulics

- Grinding impeller
- Grinding system with three-blade rotary knife

Suitable for

- Wastewater containing solids which can be broken down and filaments
- Sewage treatment systems, civil lifting



Need

- Pumping of soiled wastewater containing solids which can be broken down

Criticalities

- Presence of organic waste and processing residues

Zenit solution

UNIQA grinder (ZUG GR)

- rotary triangular steel knife able to grind up solids and fibres
- motors in efficiency class IE3 with low consumption, suitable for prolonged operation and frequent starting

Lifting in industrial wastewater treatment plant (China)
Three ZUG GR 050A 7.5/2 AW pumps

ZUG HP

Operating ranges

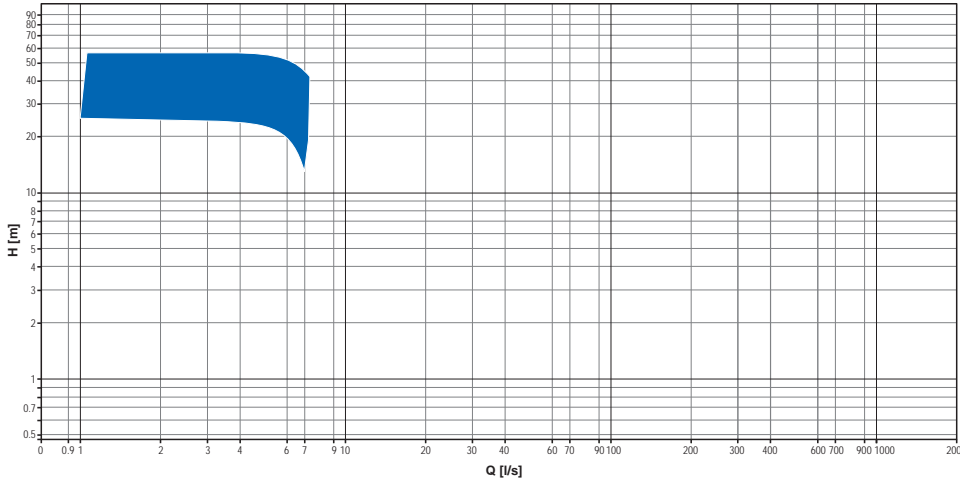

Range characteristics

Power	4 ÷ 11 kW
Poles	2
Discharge	DN50 ÷ G2"
Free passage	max 10 mm
Max flow rate	11.0 l/s
Max head	61 m

Hydraulics

- Cast iron multi-channel open impeller
- High manometric head

Suitable for

- Clean, rain and seepage water
- Suitable for applications in agriculture, irrigation and fish farming

Need

- Irrigation

Criticalities

- High pressures

Zenit solution

UNIQA with high head impeller (ZUG HP)

- high hydraulic performances
- low energy consumption

Pumping system for treated water for use in irrigation (Ireland)
Two ZUG HP 050A 9/2 AW pumps

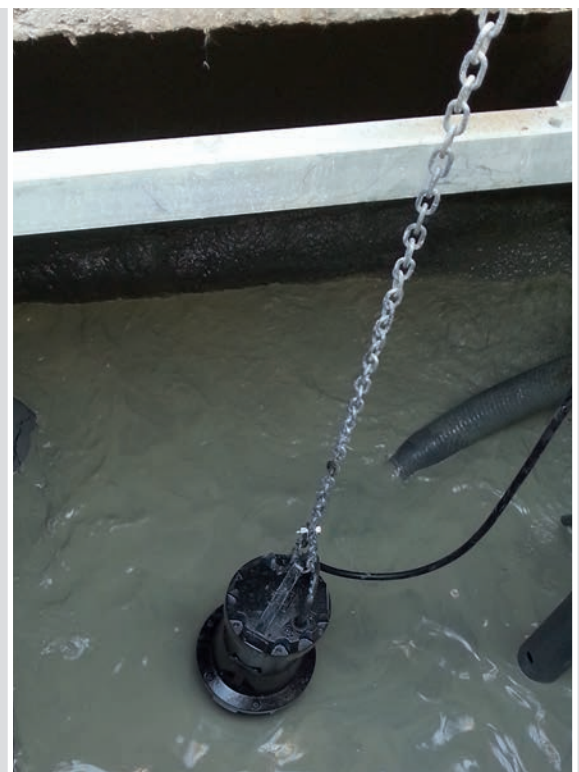



ZENIT

water solutions

ZENIT

water solutions

max 40 kg

811

ROTECNICA

132/6

The UNIQA World

UNIQA is much more than a range of submersible electric pumps **UNIQA** is a corporate philosophy. It is a world where efficiency and reliability, style and performance meet.

So **Zenit** has also applied the core principles of the **UNIQA** project to complementary products, with the same efficiency and reliability.



Mixers

New range of cast iron **mixers** with self-cleaning propellers from 200 to 900 mm in diameter.

High efficiency motor

- with direct transmission from 1.1 to 4 kW with 4, 6 or 8 poles
- with reduction gearbox coupled with motor from 4 to 18.5 kW, with 4 poles

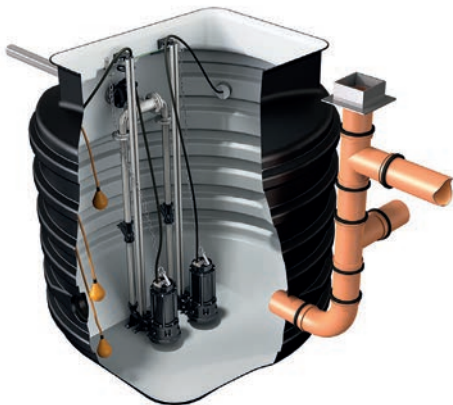

Lifting stations

BoxPRO is a high quality polyethylene tank, versatile and easy to install. A large number of technical features allow streamlined installation procedures and excellent service with low maintenance.

BoxPRO can be equipped with up to 2 pumps for systems requiring high flow rates or alternating duty cycles to avoid over-frequent start-ups.



JetOXY aerators

JetOXY submerged aerators ensure an efficient combined mixing and aeration action and they are especially suitable for homogenization and first rainfall storage tanks.

They are made by connecting UNIQA submersible pumps with power levels up to 30 kW to channel-type hydraulic units with large free passage combined with OXY series ejector devices.

OXY 80 and 150 units have a polyurethane (Vulkollan) diaphragm, easily replaceable without dismantling the pump from the ejector thanks to a patented system.

ZENO Navigator Suite: one-click access to the right solution for you

The Zenit online and mobile service platform for managing the before- and after-sales process.

Designed to meet the needs of sector professionals, whether you are an engineering firm, a plant operator or an installer, the ZENO portal is the most effective tool for managing your business.

The **ZENO Pump Selector** application provides useful assistance during the electric pump selection and configuration process, and the product that meets the search parameters can be swiftly identified through selection by duty point or by choosing the type of hydraulics directly.

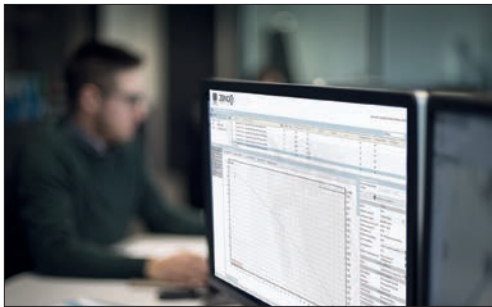

PUMP SELECTOR

The solution that provides invaluable assistance for the entire Zenit electric pump selection and configuration process, right through to generation of the final quotation.

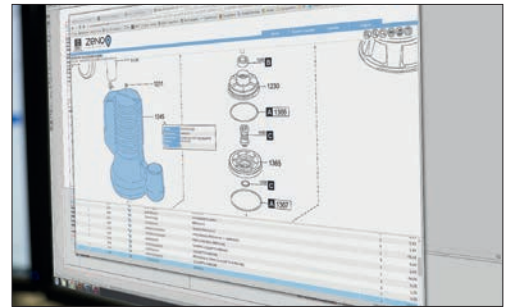

SPARE PARTS

A quick, user-friendly tool enabling you to easily select the spare part you require, add it to your cart and send off your order automatically, with just a few clicks.

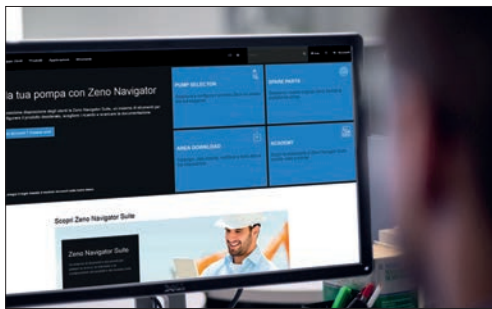

DOWNLOAD

You have access to a library of Zenit and industry technical and commercial documentation.



ACADEMY

The Academy selection offers you all information required for knowledge of and training in Zenit products and services.

Mobile, ZenoApp on smartphone and tablet, available for iPhone and Android



Web: zenit.com

Zenit Group

Today the Zenit Group ranks among the top national and international names in the design and manufacture of submersible electric pumps for domestic, civil and industrial use, and water treatment systems.

With the know-how and experience acquired over the years, Zenit offers the market a comprehensive range of products designed to meet the most demanding needs.



Our organisation

Today, **Zenit** is a modern industrial organisation with a workforce of over 250 and 4 locations worldwide, that manages its markets directly and with success, thanks to full territorial coverage.

This international expansion is driven by our desire to serve our customers better with closer proximity.

Each **Zenit** group company has its own organisation, but they all operate in pursuit of a single mutual objective. Our origin as a family business has enabled us to stay streamlined and flexible, quick to respond with effective solutions.

WE STRIVE TO BE A VALUABLE PARTNER
YOU CAN TRUST IN YOUR SEARCH FOR
WATER TREATMENT SOLUTIONS AND
SERVICES.





Come and visit us at
www.zenit.com

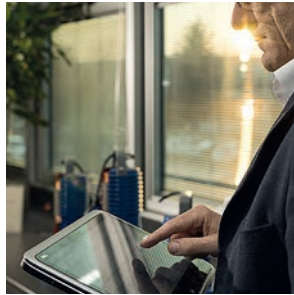

water solutions

The data provided are not binding.
Zenit reserves the right to modify any product without notice.

For further information, visit www.zenit.com

Cod. 29040060900400000
Rev. 11 - 25/09/2018

The digital version of this catalogue is available for download at: www.zenit.com